

Apex



Installation and Operation Manual EBS #10019609

www.ecolab.com

© 2014 Ecolab Inc. All rights reserved.

Introduction

This manual provides instructions for the safe installation, maintenance and operation of this dispensing controller system. Read and understand the contents of this manual before installing or operating the system. Retain this manual for future reference. Safety instructions that appear in this manual after a warning symbol ! and the words **WARNING** or **CAUTION** printed in bold face are especially important.

⚠ WARNING means there is the possibility of death or serious injury.

⚠ CAUTION means there is the possibility of minor or moderate injury.

NOTICE means the possibility of equipment or property damage only.

Principle of Apex

The Apex System is a machine warewash control system that communicates actionable and intuitive information to the customer and creates an efficient interface for Ecolab sales representatives. This control system will help the customer achieve superior results with improved operational efficiency.

System Features

Overall System Features

The Overall System features include:

- High resolution wide screen display
- Full text, multi-language display
- Intuitive alarm notifications
- Video play back
- Real time data collection for every rack washed
- Automated rack time calibration for conveyor and flight machines
- Customer facing “Status” menu for real time data
- Wireless data download and setup via the Ecolab Service Manager (ESM)
- Universal main power input (100-240 VAC , 50/60 Hz)
- Splash resistant enclosure

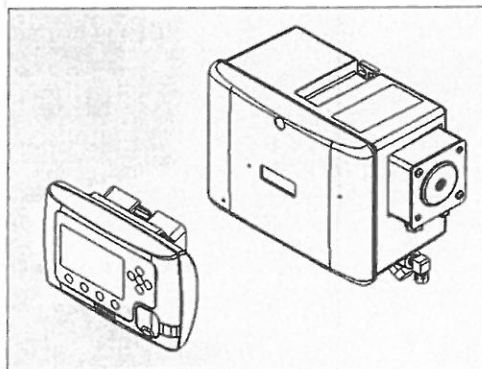

Detergent Control System

The Detergent Control System features include:

- An Inductive Probe that controls product dispensing when operating in Probe Mode.
 - “Pulse Feed” of detergent provides overshoot control when the wash tank concentration is near the desired set point
- A Timed Mode that is available for alternate detergent control when not using the probe
- A Detergent Manager that monitors probe control dispensing and automatically switches to a base lined feed condition when a dispensing error is detected
- Pre-Metering feature to charge the tank on conveyors and flight machines*

Rinse Injector System Features

The Rinse Injector System features include:

- Double roller peristaltic pump
- Squeeze tubes with different delivery rates for high or low volume installations
- Variable speed DC motor, 8 - 30 RPM
- Adjustable run time and start delay (on door machines)
- Optional Pressure Switch for alternate rinse signal input
- Rinse Manager to disable the rinse injector system during a dish machine fill (on automatic fill dish machines)
- Pump prime capability

***NOTE:**

In section 4.0 Controller Setup and in the menu screens, it says a third product is an option. For Apex EUROPE version this is used as Pre-Metering signal.

Specifications

Dimensions and Space Requirements

Controller and I/O Enclosure Dimensions

Controller Dimensions

- Height 5.6" (14.2 cm)
- Width 8.0" (20.3 cm)
- Depth 2.6" (6.6 cm)

I/O Enclosure Dimensions

- Height 9.2" (23.4 cm)
- Width 14.7" (37.3 cm) w/door open
- Width 10.7" (27.1 cm)
- Depth 5.5" (14.0 cm)

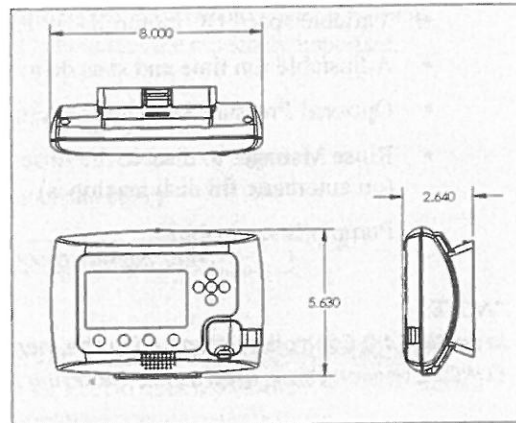

Figure 2.1

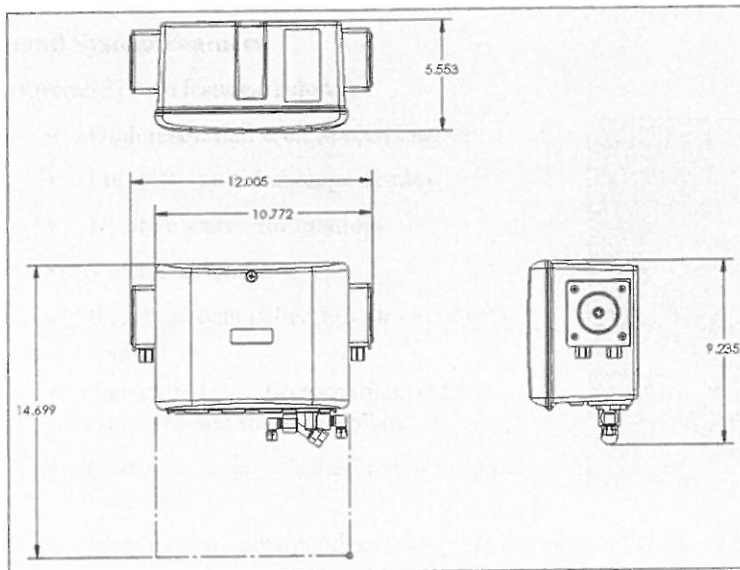

Figure 2.2

Electrical Requirements

The Apex I/O Enclosure operates within the following:

- Incoming Power
 - 100 to 240 VAC , 50/60 Hz
- Detergent and Rinse Signal inputs
 - 24 to 240 VAC , 50/60 Hz, or 24 VDC

NOTICE

If the primary voltage is 440/480 volts, separate, externally mounted transformers are required (e.g. EE-PN 418911063).

Inputs (See Wiring Diagram)

The Apex Controller operates with the following inputs (I/O Enclosure):

- Inductive Probe (mandatory for operation in probe mode)
- Rinse Thermistor (mandatory for all Apex Installations)
- Product Lid Switches
 - Detergent Lid Switch that prevents detergent valve from opening while the lid is open
 - Solid Rinse Additive Lid Switch input (not used)

Note:

This is an optional feature used with certain external dispensers. A jumper wire has been installed in the factory to electrically connect this input.

- Product Out-of-Product Signals
 - Solid Rinse Additive Out-of-Product Signal
 - Liquid Rinse Additive Out-of-Product Signal

Outputs to External Dispensers

Apex operates with the following outputs (I/O Enclosure):

- Solid Rinse Additive Dispenser
 - Three wire output to provide 24VDC power to dispenser and send back out of product signal back to controller.

Plumbing Requirements

Water supply tubing from the building water supply to the DETERGNET solenoid valve in the Apex I/O will normally be 10 mm OD metal tubing or G3/8 stainless steel braided hoses.

Note:

Refer to the Installation and Operation Manual of the appropriate Detergent and Rinse Dispensers used for this application to aid in the installation of the Apex Controller.

Apex Controller Installation

⚠ WARNING

Disconnect electrical power supply and follow lockout/tagout procedures before installing or performing service on the system.

⚠ WARNING

Electrical and grounding connections must comply with the applicable portions of the National Electrical Code, ANSI/NFPA 70 (latest edition) and/or other electrical codes.

Mounting Controller

1. Choose an installation location that:
 - Allows visual display of the Apex Controller (see figure 4.1 below)
 - Permits shortest possible tube, wire, and conduit lengths.
 - Provides accessibility for adjustments and servicing.
 - Provides as much protection from moisture/steam and heat as possible.
2. Secure Controller
 - Mount to the top or side of the dish machine using the wall mount and L-bracket
 - To flush mount to the wall or dish machine use only the wall mount bracket

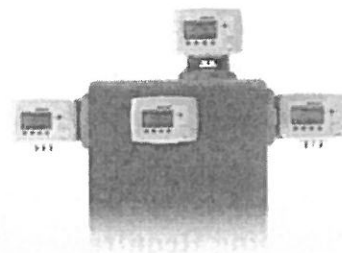

Figure 3.1

Note:

Avoid mounting the controller in areas near the dish pre-scrub area, and the rinse section of the dish machine due to excessive water, heat and food soil.

Connect RS-485 Communication Cable to Apex Controller

3. Remove the back cover from controller by removing the two retaining screws.
4. Insert one end of the RS-485 communication cable to the open plug on the controller board. Note: The other end of this cable will be connected in the I/O enclosure.
5. Install the back cover using the two retaining screws

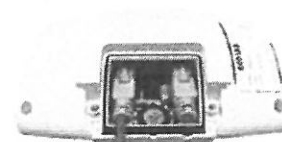

Figure 3.2

Mount and adjust the controller

1. Mount the controller to the wall mount bracket. It is necessary to first depress the release tab before sliding the controller on to the wall bracket.
2. Adjust the viewing angle of the controller by depressing the release tab and sliding the controller on to the wall bracket. Make sure the release tab engages with the back of the controller at one of the three positions.



Figure 3.3

Mount Apex I/O Enclosure

Attach the Apex I/O mounting bracket to the wall using the supplied screws and plastic wall anchors. The installation should be secure, neat, and level. see Figure 3.4

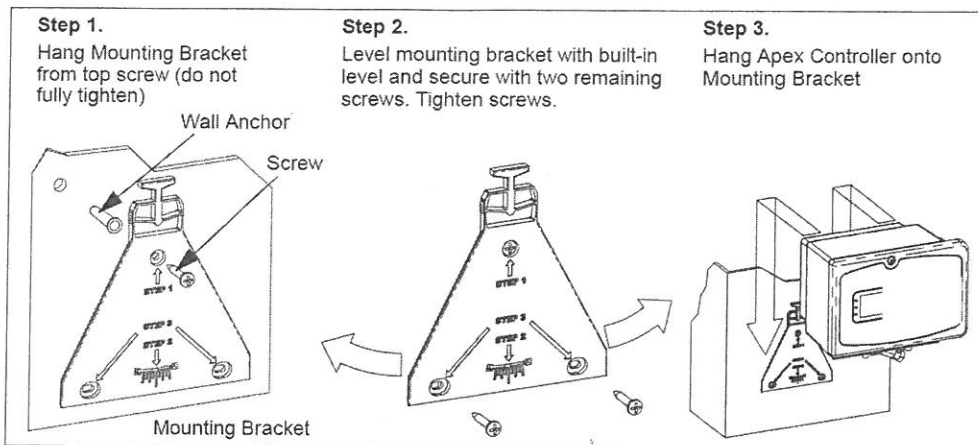

Figure 3.4

Inductive Probe Installation

For optimal equipment performance and reliability choose a location that is:

- A minimum of 2" (5 cm) from the tank bottom, side wall, overflow piping, etc.
- As far as possible (2" [5 cm] minimum) from heater elements or coils
- Protected from physical hazards.
- Always underwater, with entire Probe constantly submerged, particularly on shallow tank machines.

⚠ WARNING

Before drilling the hole in the wash tank, identify and avoid any obstructions both inside and outside the wash tank.

Installations Steps

1. Drill/Cut a 7/8" (22 mm) hole into the wash tank wall.
2. Install the rubber sealing washer onto the probe (over the threads and against the flange on the probe).
3. From the inside of the tank, route the wire through the hole until the probe is against the wall of the wash tank. Secure the Inductive Probe to the wash tank using the provided retaining nut with the O-Ring against the outside surface of the tank wall. The nut end of the Inductive Probe must be on the outside of the machine wall, refer to Figure 3.5

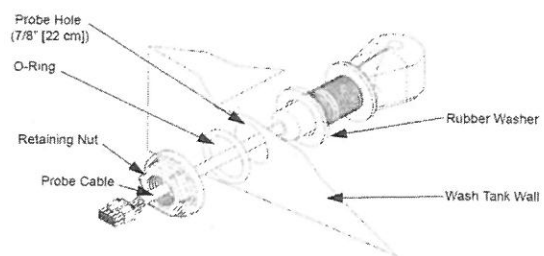

Figure 3.5

Rinse Thermistor/Injection Installation

The rinse aid injection point must be installed downstream of the vacuum breaker, and a minimum of 6" (15.2 cm) vertically below the vacuum breaker.

Note:

Some international installations require this distance to be 30 cm (11.8"). The enclosure must be mounted so that the top of the rinse dispenser pump is below the injection point.

NOTICE

Install fittings using Teflon tape or pipe sealant to prevent leaks

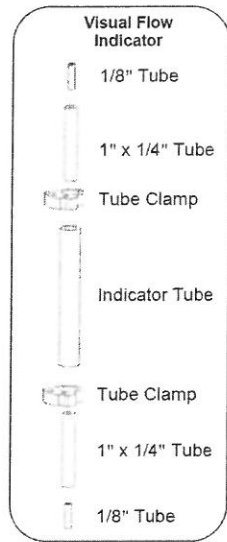

Figure 3.7

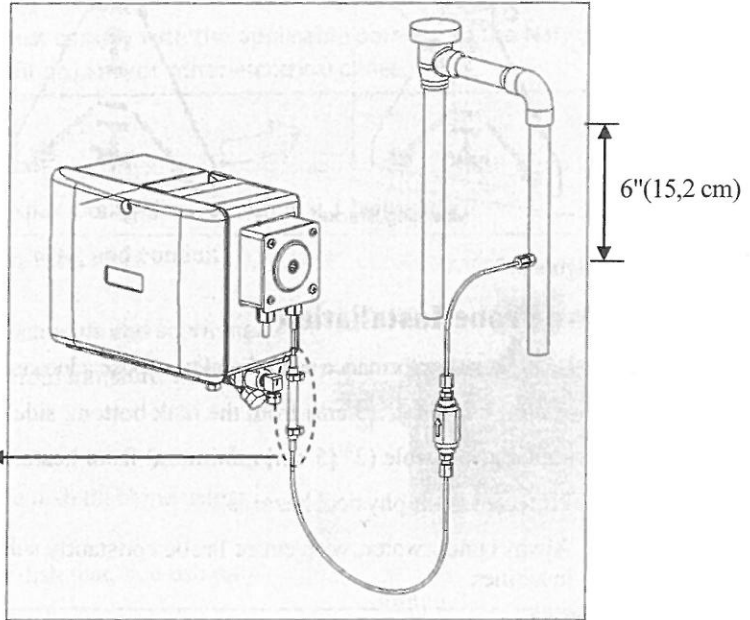

Figure 3.6

1. Identify point at which rinse additive will be injected into final rinse line.
2. Attach Rinse Thermistor to outside of metal plumbing securely. Try to get Thermistor as close as possible to injection point of rinse additive for most accurate reading.
3. Assemble the Visual Flow Indicator (required for NSF listing) on the outlet side of the rinse dispensing pump by inserting the 1/8" tube fully into one of the two 1" sections of 1/4" OD x 1/8" ID PVC tubing provided (see Figure 3.7)
4. Install the check valve between the visual flow indicator and the rinse aid injection point.

Water Line Connections

Detergent Valve

1. Connect 10 mm O.D. metal tubing or G 3/8 stainless steel braided hose from the building water supply to the inlet side of the solenoid valve, located at the bottom of the Apex I/O enclosure.

Note: Tighten down the cap nut using second open end wrangle.

2. Connect 8 mm O.D. BLUE plastic tubing from the outlet side of the solenoid valve to the Apex Detergent Dispenser.

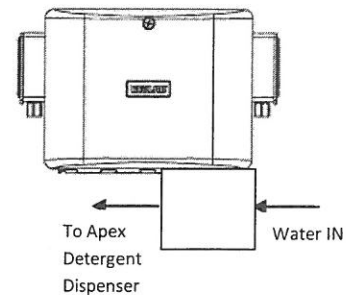

Figure 3.8

Note:

Refer to the Installation and Operation Manual of the Apex Detergent Dispenser for water temperature and flow rate requirements.

Pressure Switch (Optional)

If the dish machine does not offer a separate rinse signal to activate the rinse additive, a pressure switch will need to be installed. The rinse injector will then be activated when the switch closes from the pressure created by the flow of the final rinse water.

1. Locate hexagon feature on the bottom of the I/O enclosure, located in front of the detergent valve (Figure 3.9).
2. From the outside of the enclosure, knock out the plastic piece that covers this hexagon hole.
3. From the inside of the enclosure, insert pressure switch in the hexagon hole. Secure pressure switch using mounting nut.

Note: See figure 3.10 for wiring instructions.

4. Connect 1/4" copper tubing between the pressure switch on the outside of the enclosure and the injection fitting on the final rinse line.

Note: Pressure switch is not included in the installation kit, order if needed

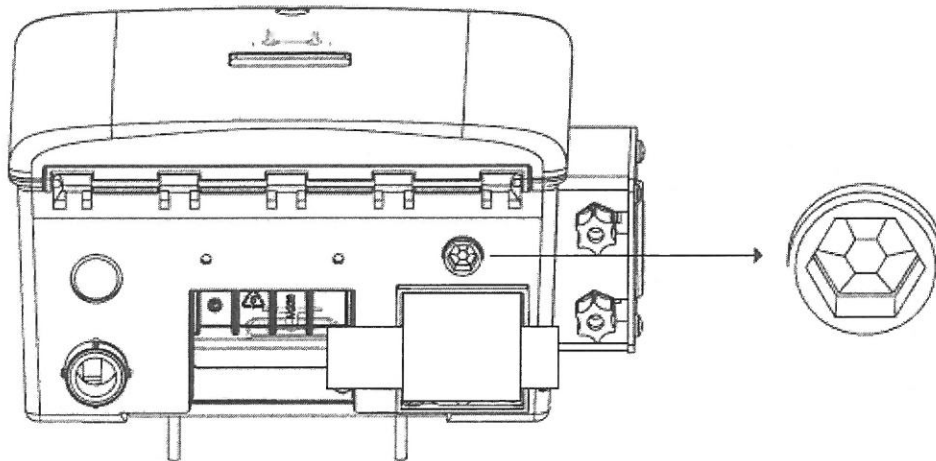

Figure 3.9

Electrical Installation

⚠ WARNING

Disconnect electrical power supply and follow lockout/tagout procedures before installing or performing service on the system.

⚠ WARNING

Electrical and grounding connections must comply with the applicable portions of the National Electrical Code, ANSI/NFPA 70 (latest edition) and/or other electrical codes.

High Voltage and Machine Signal Wiring

Electric Power Supply

Apex is designed to be permanently connected to the dish machine to receive the main power and dispenser enabling signals. The dish machine will normally contain an identified terminal block for this purpose. Refer to the wiring diagram of the dish machine. The dish machine installation should include a disconnect switch and overcurrent protection as required by national and/or local electric codes.

If Apex must be connected to a source other than the dish machine for the main power, the electrical, overcurrent protection and grounding connections must comply with the applicable portions of the National Electric Code, ANSI/NFPA 79 (latest edition), and/or other local electrical codes.

The system can operate within the following specifications:

- Incoming Power
 - 100 to 240 VAC , 50/60 Hz
 - Required circuit/fuse protection: 3.0 A maximum
- Detergent and Rinse Signal inputs
 - 24 to 240 VAC , 50/60 Hz.
 - Required circuit/fuse protection: 20 mA maximum
 - 24 VDC
 - Required circuit/fuse protection: 5 mA maximum

Cable for Electrical POWER Connections

A 25 foot long (7.62 m), three-conductor power cable is provided and pre-connected inside the Apex I/O enclosure. This cable is used to provide incoming power from the dish machine to the Apex. If this wire cannot be used because of specific reasons at the installation, it must be replaced with 18 AWG (minimum) wire having minimum ratings of 300 V and 105 °C insulation.

Cable for Electrical MACHINE SIGNAL Connections

A 25 foot long (7.62 m), six-conductor signal wire cable is provided and pre-connected inside the Apex I/O enclosure. This cable is used to provide dispenser enabling signals from the dish machine to the Apex. If this wire cannot be used because of specific reasons at the installation, it must be replaced with 18 AWG (minimum) wire having minimum ratings of 300 V and 105 °C insulation.

Conduit for Electric Cable

The power and signal wire cable between the dish machine and the Apex I/O enclosure does NOT need to be enclosed in liquid tight electrical conduit approved for use in damp locations. However, a threaded 1/2" trade size female connection exists for connecting the conduit to the bottom of the Apex I/O enclosure.

Note:

For proper operation, both Detergent Signal and Rinse Signal (or pressure switch) connections must be connected for all installations.

Main Power (3 conductor cable)

Connect Blue and Brown wires to constant voltage source.

Connect Green with Yellow stripe wire to verified earth ground.

NOTICE

If the primary voltage is 440/480 volts, separate, externally mounted transformers are required (e.g. EE-PN 418911063).

Dishmachine Signals (6 conductor cable)

DETERGENT SIGNAL:

Connect BLACK and WHITE wires to dish machine detergent power source (or wash pump circuit if no detergent power source connections are provided).

This is a universal voltage signal input that is capable of accepting any voltage between 24 to 240 VAC, 50/60 Hz, or 24 VDC. (DC voltage input must observe polarity; WHITE wire is positive.)

RINSE SIGNAL:

Connect GREEN and RED wires to dish machine rinse power source (or rinse solenoid valve circuit if no rinse power source connections are provided).

This is a universal voltage signal input that is capable of accepting any voltage between 24 to 240 VAC, 50/60 Hz, or 24 VDC. (DC voltage input must observe polarity; RED wire is positive.)

NOTICE

When using the optional pressure switch, the electrical signals from the dish machine are not used. Disconnect the green and red stripe wires from the terminal block.

PRE-METERING SIGNAL:

Connect BLUE and ORANGE wires to fill signal from the dish machine.

This is a universal voltage signal input that is capable of accepting any voltage between 24 to 240 VAC, 50/60 Hz, or 24 VDC. (DC voltage input must observe polarity; ORANGE wire is positive.)

Main Power and Signal Cable Wire Color Codes

Wire Color	Connect to
Brown	Main Power: 100 – 240 VAC 50/60 Hz
Blue	Main Power: 100 – 240 VAC 50/60 Hz
Green w/Yellow	Earth Safety Ground
Black	Detergent Signal: 24-240 VAC or 24 VDC (-)
White	Detergent Signal: 24-240 VAC or 24 VDC (+)
Green	Rinse Signal: 24-240 VAC or 24 VDC (-)
Red	Rinse Signal: 24-240 VAC or 24 VDC (+)
Blue	Pre-Metering Signal: 24-240 VAC or 24 VDC (-)
Orange	Pre-Metering Signal: 24-240 VAC or 24 VDC (+)

Apex I/O Board Connections

Note:

The components inside the Apex I/O enclosure are prewired

Pass wires through the hole in the Apex I/O enclosure for the cable sealing block and connect to I/O Apex I/O board. Wires to pass through sealing block include:

- Controller via RS-485 Communication Cable
- Inductive Probe
- Solid Rinse Aid Dispenser Power (RED +, BLACK -)
- Rinse Aid IR Sensor, Out-of-product signal (connect to location 'S' on Rinse Sensor Connector)
- Rinse Thermistor
- Detergent Dispenser Lid Switch

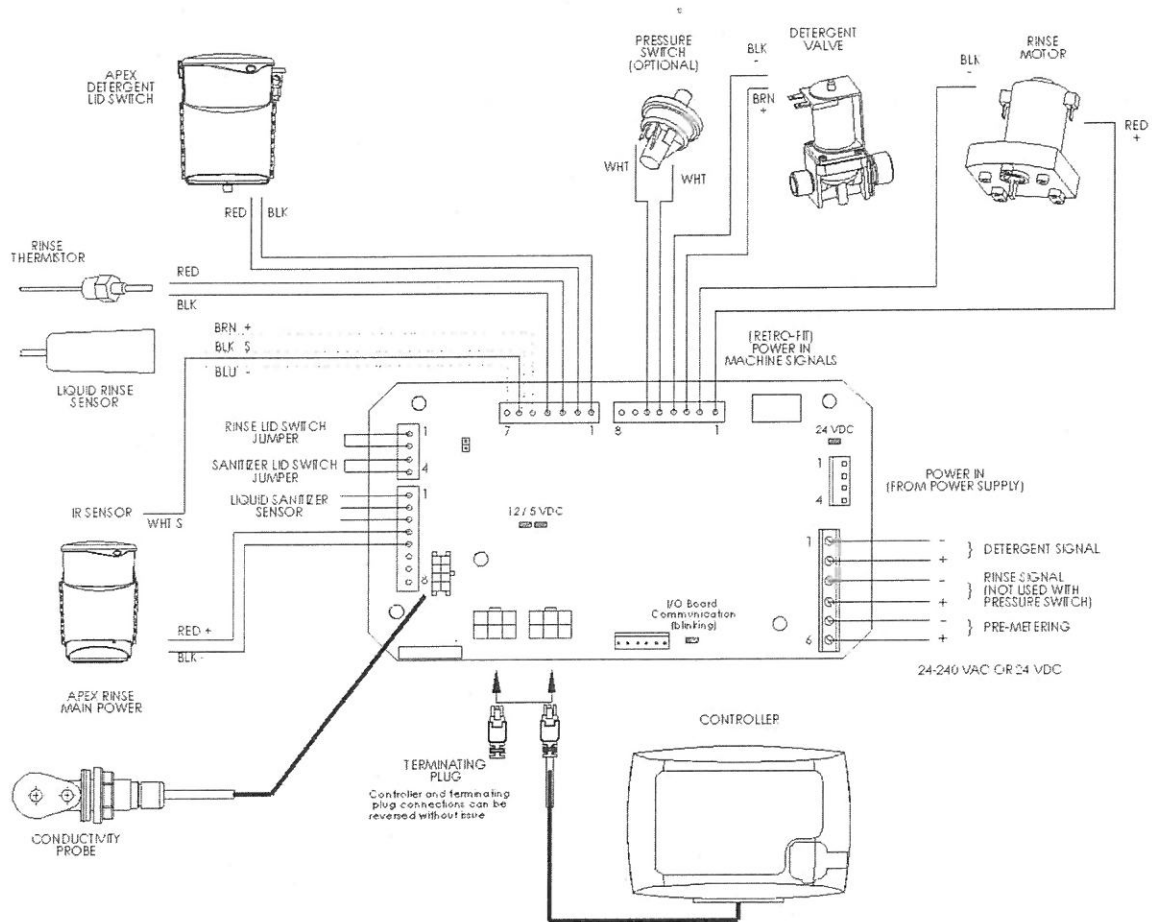

Figure 3.10

Sealing Block Installation

NOTICE

The cable sealing block must be used and correctly installed to prevent moisture from entering the enclosure and causing damage to the electrical components. Wrap excess cable outside of the I/O enclosure to prevent electrical noise interference.

After making wire connections, install the cable sealing block inside the Apex I/O Enclosure.

1. Place sealing block underneath wires and align the guides into position
2. Press firmly in the forward and downward direction until the block is securely in place

Note:

For best sealing results, avoid having cables lying on top of each as they pass through the opening at the sealing block

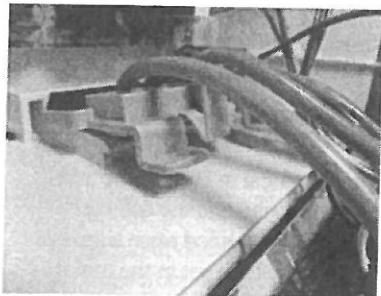

Figure 3.11



Figure 3.12

Electrical Noise Suppressor Installation

The electrical noise suppressor (ferrite core) must be installed on the communications cable.

1. Route communications cable through the sealing block opening in the I/O box.
2. Connect end of communications cable to I/O board (see connection diagram in "Apex2 I/O Board Connections" section).
3. Install sealing block.
4. Install the noise suppressor on to the communications cable at a point just inside the cable sealing block. The noise suppressor snaps together around the cable.

Controller Setup

All setup parameters are accessed through the “Main Menu “of the Apex controller.

Dish Machine Mode

The dish machine mode can be set in the “Setup System > Machine ” menu. The dish machine setup will determine what dispensing parameters are available in the “Adjust Dispensing” menu. The dish machine modes available are below.

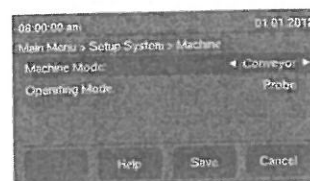

Figure 4.1

1. Door Machine – Probe Mode:

In Door Machines, the rinse is triggered by either the rinse signal or the (optional) pressure switch. As the rinse is triggered, the rinse delay (if any) begins. After the delay, the rinse pump runs at the set rinse pump speed for the programmed Rinse Pump Limit or until the rinse input is turned off, whichever comes first.

2. Door Machine – Timed Mode:

Door machine functionality, such as rack counting and rinse dispensing, are identical in both Probe and Timed mode. However, Timed Mode does not have a wash tank monitoring function and the detergent dispensing is different. When the first detergent signal is received following an unqualified rinse signal (a rinse signal not preceded by a detergent signal), the detergent is dispensed for the time set in the Initial Detergent Charge. At each subsequent detergent signal, the detergent is dispensed for the set Detergent Valve Run Time, at the interval set in the Detergent Dose Interval.

3. Conveyor Machine – Probe Mode:

Conveyor Machine, the rinse is triggered by either the rinse signal or the (optional) pressure switch. The rinse pump is activated with a qualified rinse signal and will run throughout the duration of the signal.

4. Conveyor Machine—Timed Mode:

Conveyor machine functionality, such as rack counting and rinse dispensing, are identical in both Probe and Timed mode. However, Timed Mode does not have a wash tank monitoring function and the detergent dispensing is different. When the first detergent signal is received following an unqualified rinse signal (a rinse signal not preceded by a detergent signal), the detergent is dispensed for the time set in the Initial Detergent Charge. At each subsequent detergent signal, the detergent is dispensed for the set Detergent Valve Run Time, at the interval set in the Detergent Dose Interval.

5. Flight Machine – Probe Mode:

Flight Machine, the rinse is triggered by either the rinse signal or the (optional) pressure switch. The rinse pump is activated with a qualified rinse signal and will run throughout the duration of the signal.

Product Selection

Apex detergent and rinse additive selections are found in "Setup System – Product Selection" menus. Several controller conditions are dependent on the specific products chosen therefore products chosen must accurately reflect products being used with Apex.

1. Detergent: Product specific dispensing profiles and Out-of-Product alarm notifications.
2. Rinse Additive: Product specific Out-of-Product alarm signal input and Out-of-Product alarm notifications.

Adjust Dispensing Parameters

The dispensing parameters are set in the "Adjust Dispensing" menu. Only the parameters appropriate to the machine mode chosen will be made available.

Detergent

1. Detergent Set Point (Probe Mode Only)

Detergent concentration should be set by titrating the wash tank, then adjusting the Detergent Set Point up or down as needed to reach the desired concentration. This value ranges from 1-100 in increments of 1 with a default setting of 50. To increase the set point further activates the "Enable Multiplier button" (1-500).

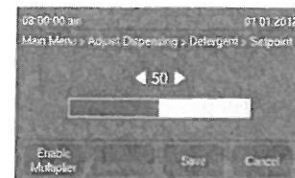

Figure 4.2

2. Detergent Valve Run Time (Timed Mode Only)

Set the length of detergent dispense time per the Detergent Dose Interval. This value ranges from 1-30 seconds in intervals of 0.1 seconds, with a default setting of 2.5 seconds.

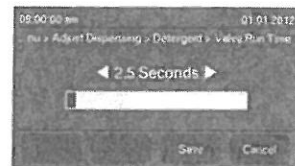

Figure 4.3

3. Detergent Dose Interval (Timed Mode Only)

Set the frequency of the Detergent Dose. This value ranges from 1-10 racks in intervals of 1 rack, with a default of 1 rack.

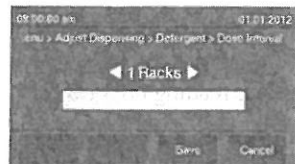

Figure 4.4

4. Initial Detergent Charge (Timed Mode Only)

Set the amount of time that the detergent will feed after the initial feed of the dish machine. This value ranges from 1-999 seconds in increments of 1 second with a default setting of 1 seconds.

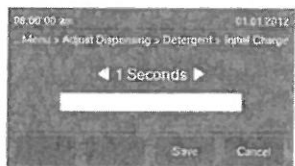

Figure 4.5

Rinse Additive

1. Pump prime

Pressing the “Start” button will turn on the rinse pump for priming. The rinse pump will run for a maximum of 30 seconds at the programmed speed or until “Stop” is pressed.

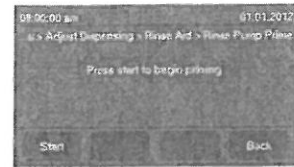

Figure 4.6

2. Pump delay (Door Mode only)

Set the delay time for starting the rinse/third product pump after receiving a qualified rinse/third product signal. This value ranges from 0-30 seconds in intervals of 1 second with a door machine default of 2 seconds.

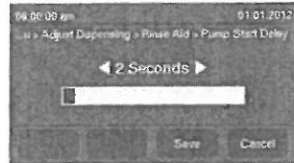

Figure 4.7

3. Pump Limit

Set the maximum time that the rinse/third product pump is allowed to run. This value ranges from 0-50 seconds in increments of 1 second, with a default of 15 seconds.

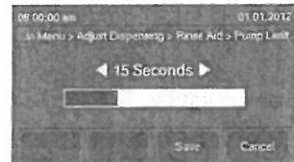

Figure 4.8

4. Pump Speed

Set the rinse/third product pump speed. This value ranges from 8-30 RPM in increments of 0.5 RPM, with a default of 15 RPM.

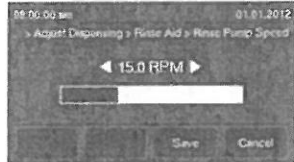

Figure 4.9

5. Adjust Rinse Temperature (Europe Only)

Calibrate the rinse temperature reading by setting the current temperature rinse reading on the machine. The setting allows an adjustment of plus or minus 59 °F (15 °C) from the current rinse temperature in steps of 1 °F (1 °C).

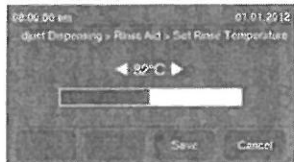

Figure 4.10

Alarming Parameters:

1. Alarm Audible

Set whether the low wash temperature, low rinse temperature and wash tank change alarms have an audible notification when the alarm is active.

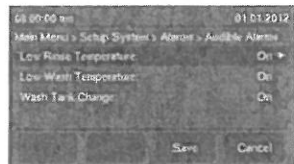

Figure 4.11

2. Alarm Volume

Set the volume of the alarm notification. This value ranges from 0 – 10 with intervals of 1.

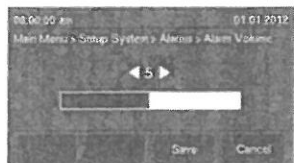

Figure 4.12

3. Detergent Alarm Delay

Set the delay time before the controller activates the Detergent Out of Product alarm. This setting monitors the time that the detergent solenoid valve is open while being below the Detergent Set Point. This value ranges from 5-1000 seconds in intervals of 5 seconds with a default of 300 seconds.

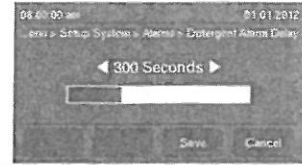

Figure 4.13

3. Wash Tank Change-Out

Set the number of racks required to activate the Change Wash Tank alarm. This value ranges from 0-950 racks in increments of 25 racks with a default of 250 racks.

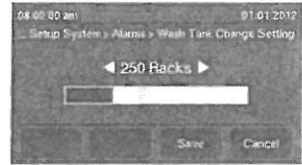

Figure 4.14

4. Alarm Mute Time

Set the duration of a muted alarm when the "Mute Alarm" button is pressed during an active alarm. Once the inputted time expires the screen Apex controller screen will revert from yellow back to red and the audible alarm will re-sound.

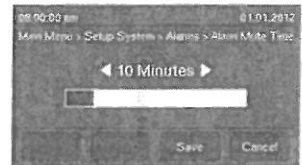

Figure 4.15

Alarm Priority

I/O Communication Error (Highest Priority)



Detergent Dispenser Lid Open



Detergent out of Product



Rinse Aid Dispenser Lid Open
(Currently not activated)

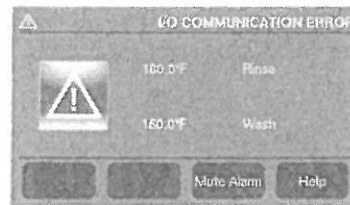

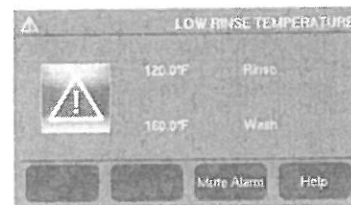
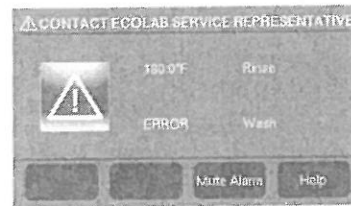
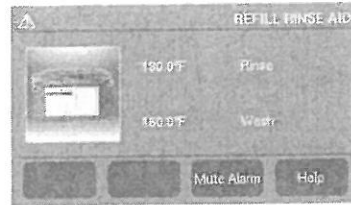
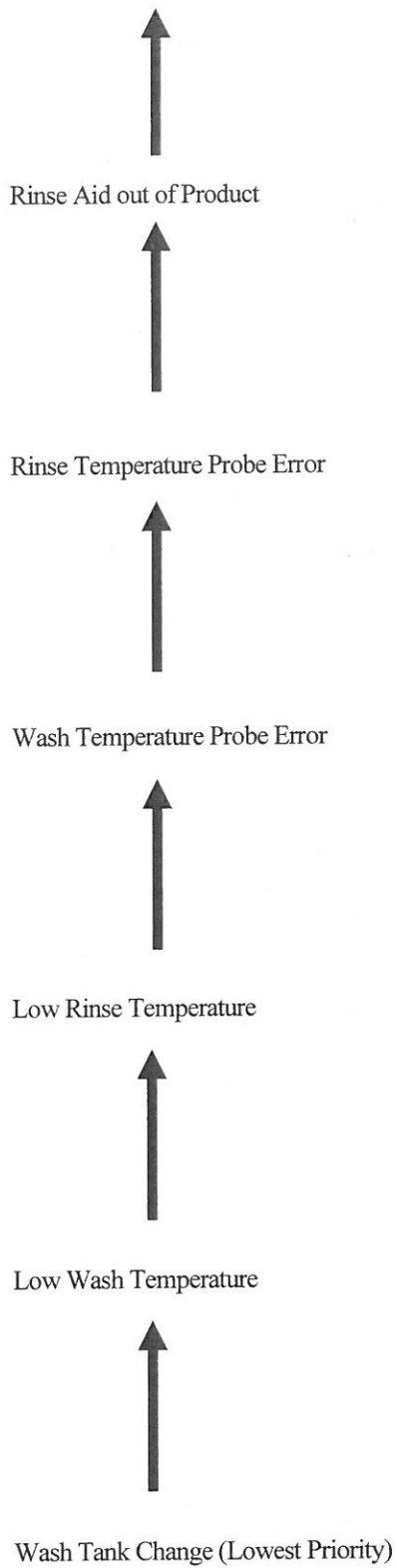

Appendix

Frequently Asked Questions

How do I know when the machine is at set point?

- Navigate to “Diagnostics & Troubleshooting – Probe Diagnostics”. The machine is at set point when Temperature Adjusted Probe Reading matches Detergent Set Point.

Do I need to set the probe offset at the installation?

- No, Apex does require setting up the dish machine probe. Product concentration must be determined through titrating the dish machine and setting a concentration setpoint, 1 – 100.

What are the 4 green lights for on the Apex I/O board?

- The blinking green light indicates communication from the Apex I/O board to the Apex Controller.
- The three other lights are board power lights. See I/O board diagram in the electrical section for further information.

Can the Apex controller play videos?

- Yes, training videos are located in the “Help” screen from the main screen and alarm videos are located in the “Help” screen during an active alarm.

Can I set the wash and rinse temperature alarming thresholds?

- Yes, but only the low temperature alarm threshold can be adjusted.

How to check for probe failures?

- See trouble shooting table.

Can I wire a Rinse Max to an Apex I/O Board?

- No, different voltage requirements. Apex is DC and Rinse Max is AC.

How do I know if I have a faulty rinse pump motor?

- See trouble shooting table.

How do I get proper rack counts?

- The Apex Rack Time Calibration Application will measure rack times automatically. This can be found in the controller at “Setup System – Set Tablet Values – Rack Time Calibration”. It's also possible to enter rack times manually.

Troubleshooting

Symptom	Action
Apex Controller Screen is blank	<ol style="list-style-type: none"> 1. RS-485 Communication Cable not connected, check cable connection plugs at controller and at I/O board 2. No power to controller <ul style="list-style-type: none"> • Check LED lights on the I/O board to confirm I/O board power • If LED lights off, check output voltage (24 VDC) of power supply (at red & black wires) • If no 24 VDC, check incoming high voltage AC to power supply (at light blue and brown wires at power supply) • If no high voltage at power supply, check for incoming high voltage AC power source (at point where light blue & brown wires are connected). • <u>Check main dishmachine AC power and main breaker</u>
Apex Controller Screen is Locked-up	<ol style="list-style-type: none"> 1. Disconnect dishmachine power for 10 seconds at breaker and reconnect <ul style="list-style-type: none"> • If problem remains replace controller
I/O Communication Alarm	<ol style="list-style-type: none"> 1. RS-485 Communication Cable not connected, check cable connection plugs at controller and at I/O board 2. RS-485 terminating plug not installed; there should be a terminating plug installed in the controller and the I/O board (see connection diagram) 3. Check I/O board Communication Light (see Figure 3.10) <ul style="list-style-type: none"> • If not blinking, disconnect machine power for 10 seconds at breaker and reconnect • If problem remains replace I/O board
Apex Controller does not feed Detergent	<ol style="list-style-type: none"> 1. Solenoid valve not operating, check valve functionality through Apex controller menu "<i>Diagnostics & Troubleshooting – Dispense Tests – Detergent Valve Test</i>" <ul style="list-style-type: none"> • If valve operates, verify correct wiring of wash signal 2. Detergent Lid Switch Open, check lid position signal through Apex controller menu "<i>Diagnostics & Troubleshooting- Dispenser Lid Position</i>" <ul style="list-style-type: none"> • If lid position is open, check wiring and switch • Replace dispenser if switch is broken 3. Detergent Valve not receiving power, check DC voltage at connector on Apex I/O board <ul style="list-style-type: none"> • If 22-24 VDC is not present during valve activation, verify wiring installation and correct polarity. <p><i>Note:</i> <i>If the valve is not connected to the board, the connection voltage will read 18-20 VDC</i></p> <ol style="list-style-type: none"> 4. Solenoid Valve Inspection: <ul style="list-style-type: none"> • Check for Water at the Valve – Disconnect outlet tubing from the valve. Check for water flow through the valve using the Apex controller menu "<i>Diagnostics & Troubleshooting – Dispense Tests – Detergent Valve Test</i>". If water flow is present, check for restrictions in the tubing to the detergent dispenser or in the dispenser's spray nozzle • Check incoming static water pressure. The valve will not

Symptom	Action
	<p>operate if pressure is greater than 6,89 bar. If greater than 6,89 bar use alternate water source or install a pressure reducing valve.</p> <ul style="list-style-type: none"> • Check filter on Solenoid Valve for clogs
Apex Controller Continuously feeds Detergent	<ol style="list-style-type: none"> 1. Solenoid Valve malfunction: check valve <ul style="list-style-type: none"> • Disconnect machine power (disconnect power to the controller) • If detergent continues to feed, repair/replace the solenoid valve 2. Excessive wash tank dilution with fresh water <ul style="list-style-type: none"> • Check for faulty tank drain causing constant filling • Check for excessive rinse overflow to the wash tank • Check if detergent being diverted away from wash tank •
Rinse Pump does not activate	<ol style="list-style-type: none"> 1. Rinse Lid Switch input is open, check lid position signal through Apex controller, menu "<i>Diagnostics & Troubleshooting- Rinse Lid Position</i>" <ul style="list-style-type: none"> • If lid position is open, Rinse Lid Switch input on I/O board not jumpered; add jumper wire between terminals 2. Rinse Pump Motor not functioning; check motor using "<i>Diagnostics & Troubleshooting – Dispense Tests – Rinse Pump Test</i>" <ul style="list-style-type: none"> • If motor operates, check wiring and presence of the rinse signal on the I/O board, and check rinse pump delay setting • If motor does not operate, check for DC voltage at rinse pump terminals on I/O board. During Rinse Pump Test, if voltage is greater than 1 VDC, and if properly wired, replace motor. If voltage less than 1 VDC replace I/O board
Apex Controller wash temperature does not match machine wash temperature gauge	<ol style="list-style-type: none"> 1. Sample the wash tank and measure temperature with a calibrated thermometer <ul style="list-style-type: none"> • If value matches controller, discuss replacing the wash tank temp gauge with the customer. • If value matches the machine gauge, replace detergent probe. <p><i>Note:</i> <i>Ensure the probe is in a location that will provide an accurate representation of the temperature of the wash tank. Differences of up to +/-5 °C between the Apex controller reading and the dish machine gauges are acceptable.</i></p>
Apex Controller rinse temperature does not match machine rinse temperature gauge	<ol style="list-style-type: none"> 1. Incorrect installation of Rinse Thermistor, see installation section 2. Machine rinse temperature gauge failure; check machine rinse gauge temperature. If it thought to be faulty, discuss replacing the gauge with the customer. <p><i>Note:</i> <i>Ensure the probe is in a location that will provide an accurate representation of the temperature of the rinse heater or plumbing. Differences of up to +/-5 °C between the Apex controller reading and the dish machine gauges are acceptable.</i></p>

Symptom	Action
Rinse Additive Out-of-Product alarm is ON continuously	<ol style="list-style-type: none"> 1. Solid Rinse Additive sensor malfunction, check sensor using "Diagnostics & Troubleshooting – Out of Product Alarms – Rinse Aid." <ul style="list-style-type: none"> • Block and unblock sensor to check functionality, if status does not change check wiring and replace Rinse Aid Dispenser IR sensor as needed 2. Liquid Rinse Additive sensor <ul style="list-style-type: none"> • Check sensor using "Diagnostics & Troubleshooting – Out of Product Alarms – Rinse Aid." Remove sensor from housing and place hand over sensing target, if status does not change check wiring and replace capacitive sensor as needed <p><i>Note:</i> See Installation section for correct installation procedure.</p>
Rinse Pump runs, no Rinse Additive injected	<ol style="list-style-type: none"> 1. Check Rinse Dispenser; verify rinse aid solution in sump. Service as necessary 2. Remove rinse aid tube from injection fitting at dish machine. Activate final rinse: <ul style="list-style-type: none"> • If product is dispensed, replace check valve • If no product is dispense, replace pump squeeze tube 3. Check injection fitting for obstruction, clean or replace as needed 4. Check squeeze tube for wear and replace, if needed
Rinse Aid Pump will not prime	<ol style="list-style-type: none"> 1. Check tubing connections for air leaks 2. Check for high rinse pressure 3. Optimum is 1-1.4 bar and cannot be over 2.4 bar. Check Squeeze tube for wear and replace if needed
Rack Counting is not accurate	<ol style="list-style-type: none"> 1. Final Rinse Signal malfunction, check rinse icon and verify if status is on only during rinse <ul style="list-style-type: none"> • If running continuous, correct the machine problem • If signal inconsistent, check for bent rails and jammed racks 2. Incorrect Rack Time, check "Setup System – Set Tablet Values" if first/or trailing rack time are invalid re-run "Rack Time Calibration": "Setup System – Set Tablet Values – Rack Time Calibration" <p><i>Note:</i> Use typical customer racks for rack-time calibration.</p>
Ethernet Connection Issue	<ol style="list-style-type: none"> 1. Ethernet Communication Interrupted, check connectivity lights on the Ethernet on the front of the Apex controller and on the connector on the Tablet PC. When Ethernet cord is connected and during data transmission, there should be a solid green and blinking yellow light) <ul style="list-style-type: none"> • If the lights are off: disconnect and re-connect Ethernet cable and/or try a new Ethernet cable.

Performance Check

Regular Inspection

1. Inspect the pump squeeze tube. If visibly worn or cracking, replace the squeeze tube even if it is working properly at the time.
2. Inspect all tubing connections for leaks, crack or loose fittings. Tighten or replace as necessary.

Squeeze Tube Replacement Instructions

1. Loosen tube nuts on pick-up and discharge ends of the squeeze tube to remove pick-up and discharge tubing.
2. Loosen four pump screws, and remove cover from face of the peristaltic pump.
3. Pull both ends of the tube away from the pump body until tube slips over rollers.
4. Clean inside of pump body, wiping to remove particle matter and accumulation of old lubricant.
5. Inspect the roller assembly closely for signs of wear or cracking.
6. Slide the plastic fittings provided with new squeeze tube inside the pump housing. It may be beneficial to use a screwdriver to rotate the roller assembly clockwise to assist in the placement of the squeeze tube.
7. Lubricate the new squeeze tube and rollers. Use only silicon grease lubricant.
8. Replace the plastic cover on the face of the pump. DO NOT over tighten because plastic can stress crack if excess force is applied.
9. Connect pick-up and discharge tubing to squeeze tube.
10. Turn on final rinse (or use Rinse in Program Mode) to prime pick-up and discharge tubes and to check for proper operation of the new pump squeeze tube.

Cleaning

Wipe unit down with a damp cloth. Mild detergent may be used.

Rinse Aid Dispenser Chart

Rinse Volume Estimates

All estimated volumes in the following table assume that the standard 1 cc squeeze tube is used. If a larger tube is used scale by changing this formula:

Volume (ml) = Squeeze Tube Size (cc/rev) x Rinse Speed (rev/min) x rack rinse time (sec) x 1 min/60 sec.

	8.0 rpm	10.0 rpm	12.0 rpm	14.0 rpm	16.0 rpm	18.0 rpm	20.0 rpm	22.0 rpm	24.0 rpm	26.0 rpm	28.0 rpm	30.0 rpm
5 sec.	0.7	0.8	1.0	1.2	1.3	1.5	1.7	1.8	2.0	2.2	2.3	2.5
10 sec.	1.3	1.7	2.0	2.3	2.7	3.0	3.3	3.7	4.0	4.3	4.7	5.0
15 sec.	2.0	2.5	3.0	3.5	4.0	4.5	5.0	5.5	6.0	6.5	7.0	7.5
20 sec.	2.7	3.3	4.0	4.7	5.3	6.0	6.7	7.3	8.0	8.7	9.3	10.0
25 sec.	3.3	4.2	5.0	5.8	6.7	7.5	8.3	9.2	10.0	10.8	11.7	12.5
30 sec.	4.0	5.0	6.0	7.0	8.0	9.0	10.0	11.0	12.0	13.0	14.0	15.0
35 sec.	4.7	5.8	7.0	8.2	9.3	10.5	11.7	12.8	14.0	15.2	16.3	17.5
40 sec.	5.3	6.7	8.0	9.3	10.7	12.0	13.3	14.7	16.0	17.3	18.7	20.0
45 sec.	6.0	7.5	9.0	10.5	12.0	13.5	15.0	16.5	18.0	19.5	21.0	22.5
50 sec.	6.7	8.3	10.0	11.7	13.3	15.0	16.7	18.3	20.0	21.7	23.3	25.0

Replacement Parts Guide

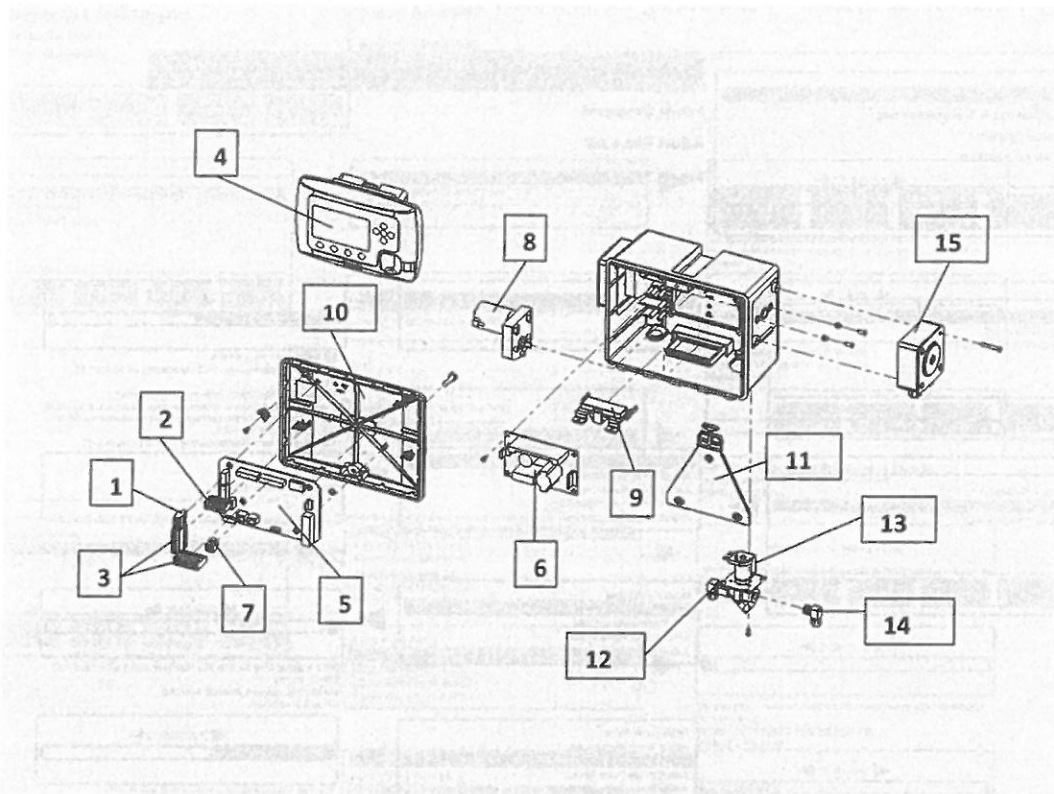

Item	EBS Part Number	EE-Part Number	EBS Description	Simple Part Name
1	Open			4-Pin Phoenix Connector
2	10023772	83111345	CONNECTOR, PLUG IN, 7 POSITION	7-Pin Phoenix Connector
3	10023771	83112102	CONNECTOR, PLUG IN, 8 POSITION	8-Pin Phoenix Connector
4	10021391	92232090	CONDOR CONTROLLER	Apex Controller
5	10023765	92232196	PRINTED WIRING ASSEMBLY, APEX I/O	Apex I/O Board
6	10023766	83494007	POWER SUPPLY, 90-264VAC IN, 24VDC OUT	Apex Power Supply
7	10023769	92000027	TERMINATING PLUG ASSEMBLY, RS485	Apex RS-485 Terminating Plug
8	10200449	274281	GEAR MOTOR 24VDC 36U/MIN PROVID. (SP)	24VDC Rinse Pump Motor
9		Only on request		Apex I/O Box Cable Seal
10		Only on request		Apex I/O Box Cover
11	Open			Apex I/O Box Mounting Bracket
12	10020649	85614000	CONNECTOR 8MM X G3/8F PUSH BRNP	Fitting 8mmOD X G3/8
13	10021372	417704157	VALVE SOLENOID 24VDC G1/2 X G3/8 EU	Solenoid Valve 24V DC G1/2 X G3/8
14	10019369	37200125	BSHG HEX G1/2FXG3/8M BRNP	Bushing G1/2 X G3/8
15	10023764	84604321	PERISTALTIC PUMP HEAD, 1CC/REV	Blue Pump with 1 cc Squeeze Tube (Apex Standard)

Note:
Begin with "Setup System" menu during the first start up.

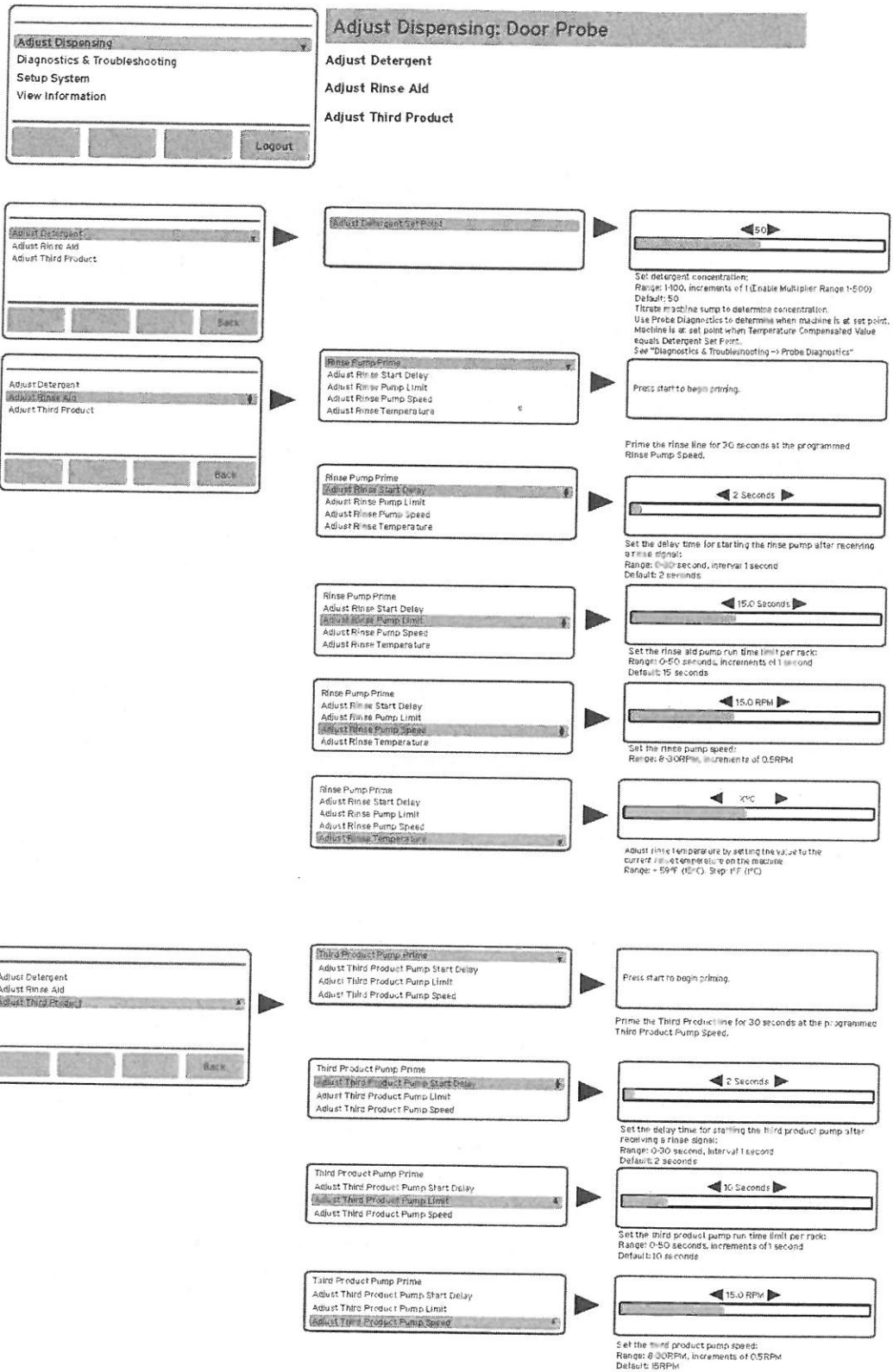

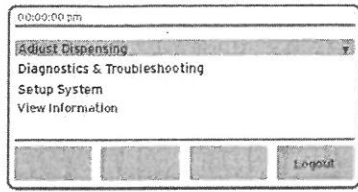

Adjust Dispensing: Door Timed

- Adjust Detergent
- Adjust Rinse Aid
- Adjust Third Product

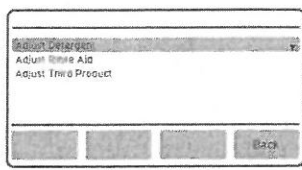

Adjust Detergent Valve Run Time
Adjust Detergent Dose Interval
Adjust Initial Detergent Charge

2.5 Seconds

Set duration of detergent dispense per rack:
Range: 1-30 seconds, interval of 0.1 seconds
Default: 2.5 seconds

Adjust Detergent Valve Run Time
Adjust Detergent Dose Interval
Adjust Initial Detergent Charge

1 Racks

Set frequency of detergent dosing:
Range: 1-10 racks, interval of 1 rack
Default: 1 rack

Adjust Detergent Valve Run Time
Adjust Detergent Dose Interval
Adjust Initial Detergent Charge

1 Second

Set the initial detergent charge after machine fill:
Range: 1-999 seconds, interval 1 second
Default: 1 second

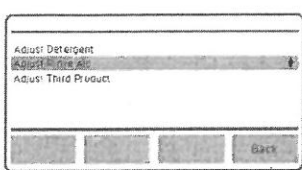

Rinse Pump Prime
Adjust Rinse Start Delay
Adjust Rinse Pump Limit
Adjust Rinse Pump Speed
Adjust Rinse Temperature

Press start to begin priming

Prime the rinse line for 30 seconds at the programmed Rinse Pump Speed.

Rinse Pump Prime
Adjust Rinse Start Delay
Adjust Rinse Pump Limit
Adjust Rinse Pump Speed
Adjust Rinse Temperature

2 Seconds

Set the delay time for starting the rinse pump after receiving a rinse signal:
Range: 0-90 seconds, interval 1 second
Default: 2 seconds

Rinse Pump Prime
Adjust Rinse Start Delay
Adjust Rinse Pump Limit
Adjust Rinse Pump Speed
Adjust Rinse Temperature

15 Seconds

Set the rinse aid pump run time limit per rack:
Range: 0-50 seconds, increments of 1 second
Default: 15 seconds

Rinse Pump Prime
Adjust Rinse Start Delay
Adjust Rinse Pump Limit
Adjust Rinse Pump Speed
Adjust Rinse Temperature

15.0 RPM

Set the rinse pump speed:
Range: 8-30 RPM, increments of 0.5 RPM

Rinse Pump Prime
Adjust Rinse Start Delay
Adjust Rinse Pump Limit
Adjust Rinse Pump Speed
Adjust Rinse Temperature

x°C

Adjust Rinse temperature by setting the value to the current Rinse temperature of the machine.
Range: +59°F (15°C), Step: 0.1°C

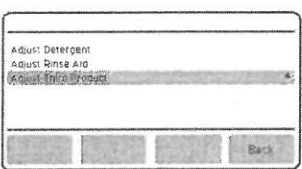

Adjust Third Product Pump Prime
Adjust Third Product Pump Start Delay
Adjust Third Product Pump Limit
Adjust Third Product Pump Speed

Press start to begin priming

Prime the Third Product line for 30 seconds at the programmed Third Product Pump Speed.

Adjust Third Product Pump Prime
Adjust Third Product Pump Start Delay
Adjust Third Product Pump Limit
Adjust Third Product Pump Speed

2 Seconds

Set the delay time for starting the third product pump after receiving a rinse signal:
Range: 0-30 second, interval 1 second
Default: 2 seconds

Adjust Third Product Pump Prime
Adjust Third Product Pump Start Delay
Adjust Third Product Pump Limit
Adjust Third Product Pump Speed

10 Seconds

Set the third product pump run time limit per rack:
Range: 0-60 seconds, increments of 1 second
Default: 10 seconds

Adjust Third Product Pump Prime
Adjust Third Product Pump Start Delay
Adjust Third Product Pump Limit
Adjust Third Product Pump Speed

15.0 RPM

Set the third product pump speed:
Range: 8-30 RPM, increments of 0.5 RPM
Default: 15 RPM
Default product selection: None

Adjust Dispensing
 Diagnostics & Troubleshooting
 Setup System
 View Information
 Logout

Adjust Dispensing: Conveyor Probe

Adjust Detergent

Adjust Rinse Aid

Adjust Third Product

Adjust Detergent
 Adjust Rinse Aid
 Adjust Third Product
 Back

Adjust Detergent Set Point

◀ 50 ▶

Set detergent concentration:
 Range: 1-100, increments of 1 (Enable Multiplier Range 1-500)
 Default: 50
 Titrate machine sump to determine concentration.
 Use Probe Diagnostics to determine when machine is at set point.
 Machine is at set point when Temperature Compensated Value equals Detergent Set Point.
 See "Diagnostics & Troubleshooting -> Probe Diagnostics"

Adjust Detergent
 Adjust Rinse Aid
 Adjust Third Product
 Back

Rinse Pump Prime
 Adjust Rinse Pump Speed
 Adjust Rinse Temperature

Press start to begin priming

Prime the rinse line for 30 seconds at the programmed Rinse Pump Speed.

Rinse Pump Prime
 Adjust Rinse Pump Speed
 Adjust Rinse Temperature

◀ 15.0 RPM ▶

Set the rinse pump speed:
 Range: 0-30RPM, increments of 0.5RPM

Rinse Pump Prime
 Adjust Rinse Pump Speed
 Adjust Rinse Temperature

◀ X°C ▶

Adjust rinse temperature by setting the value to the current rinse temperature on the machine.
 Range: +59°F (15°C), Step: 1°F (1°C)

Adjust Detergent
 Adjust Rinse Aid
 Adjust Third Product
 Back

Third Product Pump Prime
 Adjust Third Product Pump Speed

Press start to begin priming

Prime the Third Product line for 30 seconds at the programmed Third Product Pump Speed.

Third Product Pump Prime
 Adjust Third Product Pump Speed

◀ 15.0 RPM ▶

Set third product pump speed:
 Range: 0-30RPM, increments of 0.5RPM
 Default: 15 RPM

Adjust Dispensing
 Diagnostics & Troubleshooting
 Setup System
 View Information
 Logout

Adjust Dispensing: Conveyor Timed

- Adjust Detergent
- Adjust Rinse Aid
- Adjust Third Product

Adjust Detergent
 Adjust Rinse Aid
 Adjust Third Product
 Back

Adjust Detergent Valve Run Time
 Adjust Detergent Dose Interval
 Adjust Initial Detergent Charge

2.5 Seconds

Set length of detergent dispense:
 Range: 1-30 seconds, Interval of 0.1 seconds
 Default: 2.5 seconds

Adjust Detergent Valve Run Time
 Adjust Detergent Dose Interval
 Adjust Initial Detergent Charge

1 Rack

Set frequency of detergent dosing:
 Range: 1-10 racks, Interval of 1 rack
 Default: 1 rack

Adjust Detergent Valve Run Time
 Adjust Detergent Dose Interval
 Adjust Initial Detergent Charge

1 Second

Set the initial detergent charge after machine fill.
 Range: 1-999 seconds, Interval 1 second
 Default: 1 second

Adjust Detergent
 Adjust Rinse Aid
 Adjust Third Product
 Back

Rinse Pump Prime
 Adjust Rinse Pump Speed
 Adjust Rinse Temperature

Press start to begin priming

Prime the rinse line for 30 seconds at the programmed Rinse Pump Speed.

Rinse Pump Prime
 Adjust Rinse Pump Speed
 Adjust Rinse Temperature

15.0 RPM

Set the rinse pump speed:
 Range: 0-30RPM, Increments of 0.5RPM

Rinse Pump Prime
 Adjust Rinse Pump Speed
 Adjust Rinse Temperature

X°C

Adjust rinse temperature by setting the value to the current rinse temperature on the machine.
 Range: +59°F (15°C), Step: PF (1°C)

Adjust Detergent
 Adjust Rinse Aid
 Adjust Third Product
 Back

Third Product Pump Prime
 Adjust Third Product Pump Speed

Press start to begin priming

Prime the Third Product line for 30 seconds at the programmed Third Product Pump Speed.

Third Product Pump Prime
 Adjust Third Product Pump Speed

15.0 RPM

Set third product rinse speed:
 Range: 0-30RPM, Increments of 0.5RPM
 Default: 15RPM

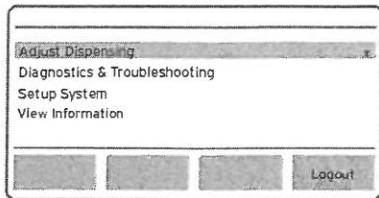

Adjust Dispensing: Flight Probe

- Adjust Detergent
- Adjust Rinse Aid
- Adjust Third Product

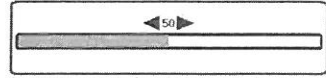
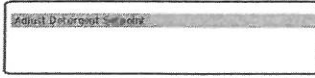
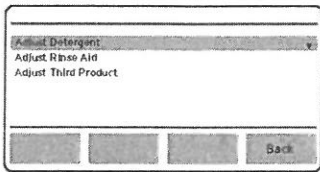

Set detergent concentration:
 Range: 1-100, Increments of 1 (Enable Multiplier Range 1-500)
 Default: 50
 Titrate machine sump to determine concentration.
 Use Probe Diagnostics to determine when machine is at set point.
 Machine is at set point when Temperature Compensated Value equals Detergent Set Point.
 See "Diagnostics & Troubleshooting -> Probe Diagnostics"

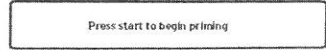
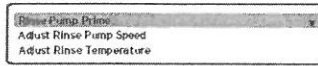
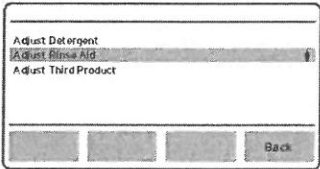

Prime the rinse line for 30 seconds at the programmed Rinse Pump Speed.

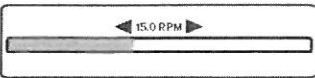
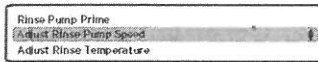

Set the rinse pump speed:
 Range: 0-30RPM, Increments of 0.5RPM

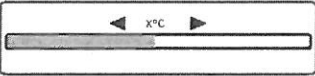
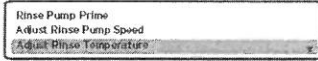

Adjust rinse temperature by setting the value to the current rinsing temperature on the machine.
 Range: +59°F (15°C), Step: 1°F (0.5°C)

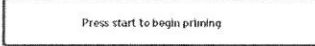
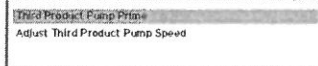
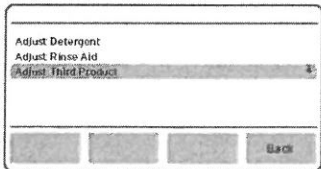

Prime the Third Product line for 30 seconds at the programmed Third Product Pump Speed.

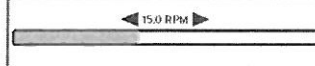
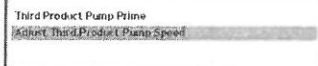

Set third product pump speed:
 Range: 0-30RPM, Increments of 0.5RPM
 Default: 15RPM

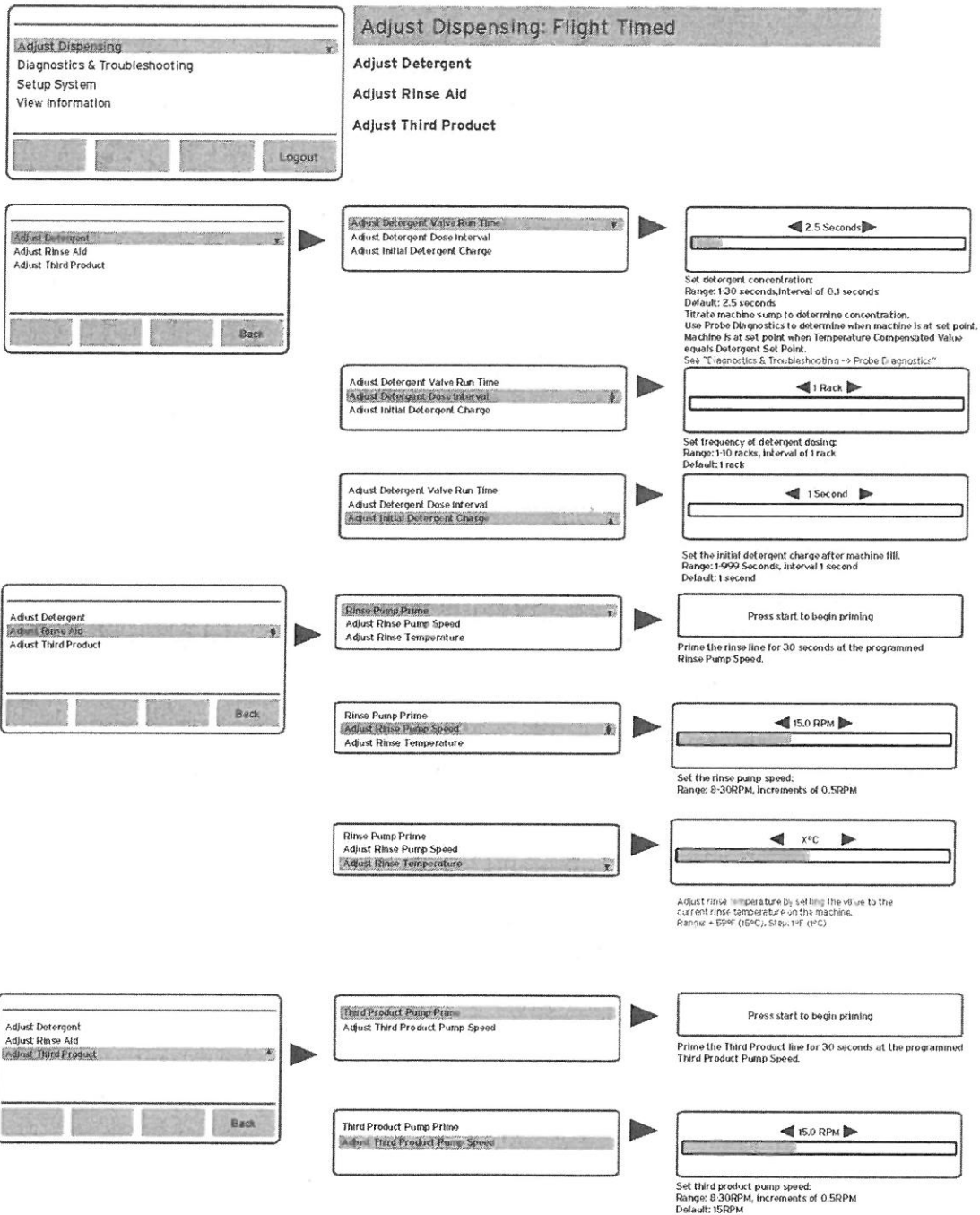

Adjust Dispensing
Diagnostics & Troubleshooting
 Setup System
 View Information

Logout

Diagnostics & Troubleshooting

Probe Diagnostics Detergent Dispenser Lid Position Machine Signal Interface Diagnostics Out of Product Alarms Dispensing Tests

Probe Diagnostics
 Dispenser Lid Switch Position
 Machine Signal Interface Diagnostics
 Out of Product Alarms
 Dispensing Tests

Detergent Setpoint: 50
 Temperature Adjusted Probe Reading: 61070
 Raw Probe Reading: 61070
 Total Dissolved Solids: 4.580896.5

Dish machine is at set point when Detergent Set Point value equals Temperature adjusted probe reading.

Probe Diagnostics
Dispenser Lid Switch Position
 Machine Signal Interface Diagnostics
 Out of Product Alarms
 Dispensing Tests

Detergent Dispenser Lid Position: Closed
 Rinse Dispenser Lid Position: Closed
 Third Product Dispenser Lid: Closed

Lid switch position of dispensers (open/closed).

Probe Diagnostics
 Dispenser Lid Switch Position
Machine Signal Interface Diagnostics
 Out of Product Alarms
 Dispensing Tests

Wash Signal: No, Qualified
 Rinse Signal: No, Not Qualified
 Third Product Signal: No, Not Qualified

Displays qualified or unqualified machine wash and rinse signals.

Probe Diagnostics
 Dispenser Lid Switch Position
 Machine Signal Interface Diagnostics
Out of Product Alarms
 Dispensing Tests

Detergent: Inactive
 Rinse Aid: Inactive
 Third Product: Inactive

Displays detergent, rinse aid and sanitizer out of product signals.

Probe Diagnostics
 Dispenser Lid Switch Position
 Machine Signal Interface Diagnostics
 Out of Product Alarms
Dispensing Tests

Detergent Valve Test
 Rinse Pump Test
 Third Product Pump Test
 I/O Board Communication Test
 LCD Screen Test
 Keypad Test
 Speaker Test

Press start to turn the detergent valve on.

Detergent Valve Test
 Rinse Pump Test
 Third Product Pump Test
 I/O Board Communication Test
 LCD Screen Test
 Keypad Test
 Speaker Test

Press start to turn the rinse aid pump on. Pump will run at 15 RPM's for 15 seconds.

Detergent Valve Test
 Rinse Pump Test
 Third Product Pump Test
 I/O Board Communication Test
 LCD Screen Test
 Keypad Test
 Speaker Test

Press start to turn the third product pump on. Pump will run at 15 RPM's for 10 seconds.

Detergent Valve Test
 Rinse Pump Test
 Third Product Pump Test
 I/O Board Communication Test
 LCD Screen Test
 Keypad Test
 Speaker Test

Press start to send a message to the I/O board.

Detergent Valve Test
 Rinse Pump Test
 Third Product Pump Test
 I/O Board Communication Test
 LCD Screen Test
 Keypad Test
 Speaker Test

Press a key below to change the screen to the specified color.

Detergent Valve Test
 Rinse Pump Test
 Third Product Pump Test
 I/O Board Communication Test
 LCD Screen Test
 Keypad Test
 Speaker Test

Press a key softly to test. The key name should appear below. Press back twice to return to the previous screen.

Detergent Valve Test
 Rinse Pump Test
 Third Product Pump Test
 I/O Board Communication Test
 LCD Screen Test
 Keypad Test
 Speaker Test

Press start to test the speaker.

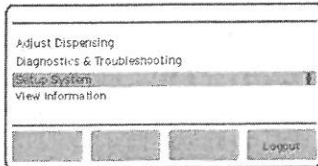

Setup System

- Machine Setup
- Product Selection
- Language Set-Up
- Alarms
- Date & Time
- Unit of Measurement
- Detergent Premetering
- Reset to Default Settings
- Set Tablet Values
- Region

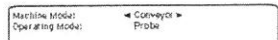
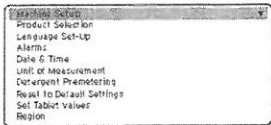

Choose machine end mode: Flight, conveyor or door, filled or probe. This determines the Adjust Dispensing menu options.

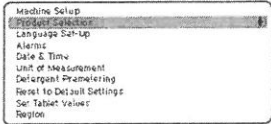

Select Detergent, Rinse Aid and Sanitizer product.

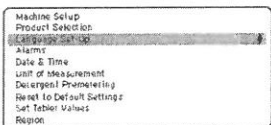

Choose primary and secondary languages.

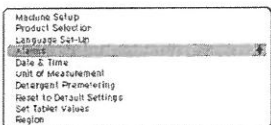

Alarm Audible Notifications:
 Detergent Alarm Delay Setting
 Wash Tank Change Setting
 Alarm Volume
 Alarm Mute Time
 Alarm Audible Notification: On/Off
 Detergent Alarm Delay: 5-300 seconds; Time delay to detergent out of product alarm
 Wash Tank Change Alarm: 0-999 racks; Number of cycles required before change-out alarm
 Alarm Volume: 1-10
 Alarm Mute Time: 1-60 minutes; Set the duration of a muted alarm before returning to the alarm state if no corrective action taken.

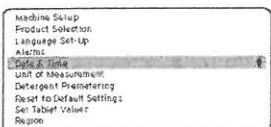

Set date and time on controller.
 Note:
 Date format: MM/DD/YY

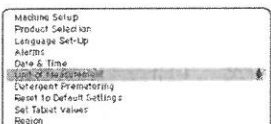

English or metric units of measure.

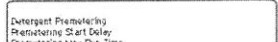
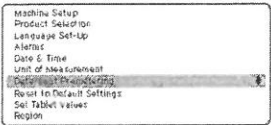

Detergent Premetering:
 Premetering Start Delay
 Premetering Max Run Time
 - Detergent Premetering: Enable or disable detergent pre-metering.
 - Premetering Start Delay: Adjust the delay before pre-metering starts following a pre-metering signal.
 - Premetering Max Run Time: Adjust the maximum run time for pre-metering. Premetering will stop when the signal stops or the max run time has elapsed, whichever occurs first.

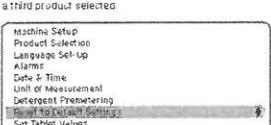

Reset the controller to clear data logs when relocating the controller to another cart/cove.

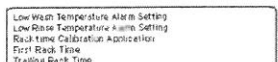
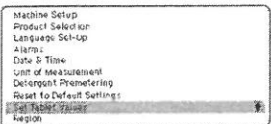

Initiate Rack Time Calibration application and view or manually set rack times. Conveyor and Flight machines only.
 Belt width only available if slight machine is selected.
 Default: 61 cm
 Range: 38-177 cm

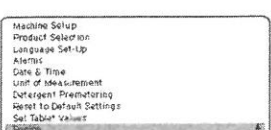

Select the region that the controller is installed in.

Adjust Dispensing
 Diagnostics & Troubleshooting
 Setup System
 View Information
 Logout

View Information

- Rack Counts
- Diagnostic Data
- Alarm Data
- Controller Board Information
- I/O Board Information

Rack Counts
 Diagnostic Data
 Alarm Data
 Controller Board Information
 I/O Board Information

Total Racks Washed	0
Racks Without Detergent	0
Racks Without Sanitizer	0
Racks Without Rinse Aid	0
Racks with Low Rinse Temperature	0
Racks with Low Wash Temperature	0
Racks with Wash Tank Change Alarm	0

Shows count of alarm events: racks at low wash temperature, low rinse temperature, without detergent, rinse aid, third product, and washed after wash tank change out alarm.

Rack Counts
 Diagnostic Data
 Alarm Data
 Controller Board Information
 I/O Board Information

Trip Product Output Times
 Master Product Output Times

Shows total signal time and run time of detergent valve, rinse pump and third product pump.

Rack Counts
 Diagnostic Data
 Alarm Data
 Controller Board Information
 I/O Board Information

01.01.2012 08:00:00 am Detergent OOP Activated
 01.01.2012 08:04:00 am Low Wash Temperature Activated
 01.01.2012 08:10:00 am Detergent OOP Deactivated

Chronological listing of alarm activations and deactivations.

Rack Counts
 Diagnostic Data
 Alarm Data
 Controller Board Information
 I/O Board Information

Serial Number: 123456
 Build Date: yyyy-mm-dd
 hh:mm:ss
 Apex 2 Version: 1.9.4
 Condor Version: 1.3.0

Apex 2 controller: Serial number, build date and software version.

Rack Counts
 Diagnostic Data
 Alarm Data
 Controller Board Information
 I/O Board Information

Serial Number:
 Build Date:
 Firmware Version:

Apex 2 I/O board: Serial number, build date and firmware version.

